

SAC-3P-M12MR/3,0-PUR SH

Order No.: 1682692



<http://eshop.phoenixcontact.de/phoenix/treeViewClick.do?UID=1682692>

Sensor/Actuator cable, 3-position, PUR, halogen-free, Black-gray RAL 7021, shielded, Plug, angled M12, A-coded, on Free conductor end, Cable length: 3 m

Commercial data	
EAN	4017918168971
Pack	1 pcs.
Customs tariff	85444290
Weight/Piece	0.1398 KG
Catalog page information	Page 79 (PC-2009)

Product notes

WEEE/RoHS-compliant since:
01/01/2008



<http://www.download.phoenixcontact.com>
Please note that the data given here has been taken from the online catalog. For comprehensive information and data, please refer to the user documentation. The General Terms and Conditions of Use apply to Internet downloads.

Technical data	
General data	
Nominal current I_N	4 A
Nominal voltage U_N	250 V
Number of positions	3
Volume resistance	$\leq 5 \text{ m}\Omega$

Insulation resistance	≥ 100 MΩ
Length of cable	3 m
Stripping length of the free conductor end	50 mm

General characteristics

Coding	A - standard
Surge voltage category	II
Pollution degree	3
Degree of protection	IP65/IP67/IP69K
Contact material	CuSn
Contact surface material	Ni/Au
Contact carrier material	TPU GF
Material of grip body	TPU, hardly inflammable, self-extinguishing
Material, knurls	Zinc die-cast, (nickel-plated)
Status display	No

Conductor data

Cable type	PUR halogen-free black shielded
Cable type (abbreviation)	PUR
Cable abbreviation	Li9Y-V1-C-V1-11Y
Conductor cross section	0.34 mm ²
AWG signal line	22
Conductor structure, signal line	42x 0.10 mm
Core diameter including insulation	1.27 mm ±0.02 mm
Thickness, insulation	≥ 0.21 mm (Core insulation) Approx. 1.1 mm (Outer cable sheath)
External cable diameter	5.90 mm
Wire colors	Brown, blue, black
External sheath, color	Black-gray RAL 7021
Insulation resistance	≥ 100 GΩ*km
Conductor resistance	max. 58 Ω/km
Nominal voltage, conductor	≤ 300 V
Test voltage, conductor	≥ 3000 V
Overall twist	3 wires, twisted
Shielding	Braided copper wires
Optical shield covering	85 %

Outer sheath, material	PUR
Material conductor insulation	PP
Conductor material	Bare Cu litz wires
Cable weight	44 kg/km
Smallest bending radius, fixed installation	59 mm
Smallest bending radius, movable installation	59 mm
Number of bending cycles	4000000
Bending radius	59 mm
Traversing path	10 m
Traversing rate	3 m/s
Acceleration	10 m/s ²
Ambient temperature (operation)	-25 °C ... 80 °C (cable, fixed installation) -5 °C ... 80 °C (cable, flexible installation)
Special properties	Flexible cable conduit capable Silicone-free Free of substances which would hinder coating with paint or varnish
Flame resistance	As per UL-Style 20549
Freedom from halogen	As per DIN VDE 0472 part 815
Resistance to oil	complying with DIN EN 60811-2-1
Other resistance	Highly resistant to acids, alkaline solutions and solvents hydrolysis and microbe resistant

Certificates / Approvals



Certification

CUL Listed, GOST, UL Listed

Diagrams/Drawings

Diagram

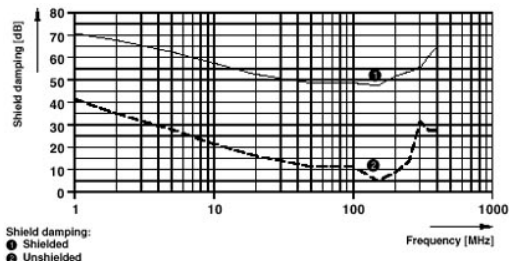

Dimensioned drawing

M12 x 1 male connector, angled, shielded

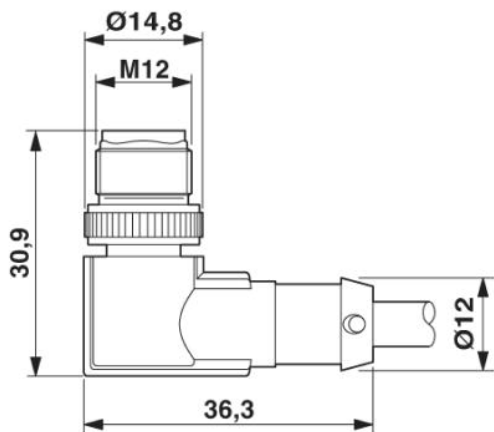

Schematic diagram

Pin assignment M12 plug, 3-pos., A-coded, view male side

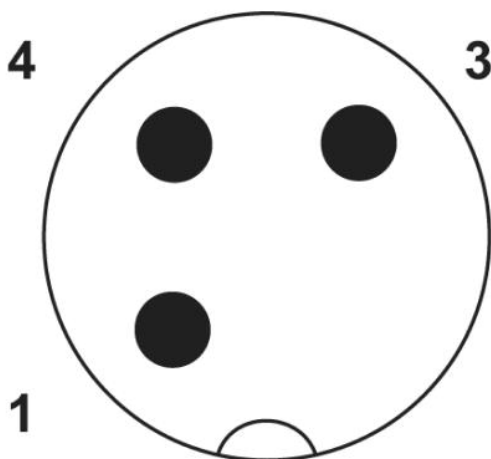

Address

PHOENIX CONTACT Inc., USA
586 Fulling Mill Road
Middletown, PA 17057, USA
Phone (800) 888-7388
Fax (717) 944-1625
<http://www.phoenixcon.com>



© 2010 Phoenix Contact
Technical modifications reserved;